

# Multi-Format Broadcast Monitor

BSM-093N3G, BSM-173N3G, BSM-183N3G,  
BSM-213N3G, BSM-243N3G



## User's Guide



**BON ELECTRONICS**  
<http://www.bon.co.kr>

# Contents

|  |    |
|--|----|
| Safety Instructions.....                               | 3  |
| Front.....   | 4  |
| Rear.....  | 6  |
| MENU Description.....                                  | 8  |
| VIDEO.....   | 9  |
| DISPLAY 1.....   | 10 |
| DISPLAY 2.....   | 12 |
| COLOR.....   | 14 |
| MARKER.....  | 15 |
| OSD.....   | 17 |
| OSD 2.....   | 19 |
| AUDIO.....   | 20 |
| GPI.....   | 22 |
| SYSTEM.....  | 24 |
| USB Firmware Update.....                               | 26 |
| External Remote Control.....                           | 27 |
| List of Compatible Video Formats (HDMI/Composite)..... | 29 |
| List of Compatible Video Formats (SDI).....            | 30 |
| Specifications.....                                    | 32 |
| Dimensions.....  | 35 |
| Troubleshooting.....                                   | 36 |
| Warranty Information.....                              | 38 |
| Modification of Product.....                           | 38 |
| Caution on Menu Operation.....                         | 38 |
| Caution for Monitor Placement.....                     | 38 |
| Caution for Usage.....                                 | 38 |

## Safety Instructions

- To help avoid damaging your monitor, connect only one power (AC or DC) in operation.
- Rough handling of product may cause physical damage or malfunction.
- Never insert anything metallic into the monitor openings. Doing so may create the danger of electric shock.
- To avoid electric shock, never touch the inside of the monitor. Only a qualified should open the monitor's case.
- Openings in the monitor cabinet are provided for ventilation. To prevent overheating, these openings should not be blocked or covered.
- Minimum 50cm (20 inches) room to wall is necessary to prevent overheating when the monitor is installed to wall.
- Put your monitor in a location with low humidity and a minimum of dust. Avoid places like damp basement or dusty hallways.
- Place the monitor on a solid surface and treat it carefully. The screen is made of glass and can be damaged if dropped or sharply hit.
- Do not attempt to remove the back cover, as you will be exposed to a shock hazard. The back cover should only be removed by qualified service personnel.
- Unplug the monitor power before you connect external devices to the monitor.
- If your monitor does not operate normally, or if there are any unusual sounds or smells coming from it, unplug it immediately and contact us.
- Please do not disassemble the monitor. No service will be provided in that case.
- Displaying fixed picture for a long time may cause an afterimage or dead spots. To recover LCD pixels, display whole white picture on screen for a n hour or two and pixels will be recovered.
- No service will be provided for user's own color calibration.

## Front

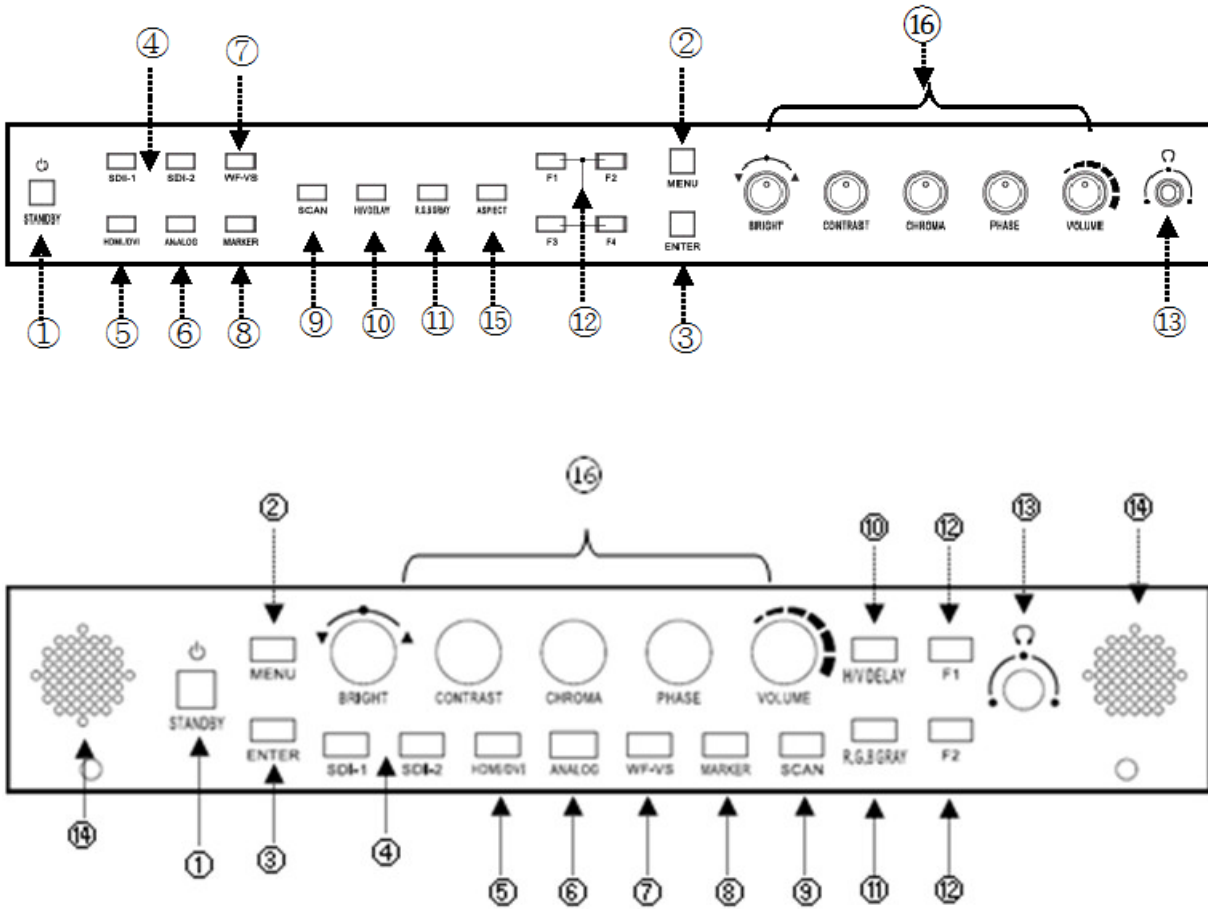

1) Power

2) Menu

3) Enter

4) SDI 1, SDI 2 Input

5) HDMI/DVI Input

6) Analog

Switch analog input in the order of CVBS1 -> CVBS2 -> CVBS3 -> SVIDEO -> YPbPr -> RGB -> VGA.

7) WF/VS

Waveform / Vectorscope display selection button.

**8) Marker On/Off**

**9) Scan**

Switch scan mode among Zero Scan, Under Scan, Over Scan, Pixel to Pixel in HD resolution. Zero Scan, Under Scan, Over Scan, Pixel to Pixel in SD resolution.

**10) H/V Delay**

**11) R/G/B Gray**

Switch for Red/Green/Blue/Gray only.

**12) Function Keys**

User-assigned function keys.

**13) Headphone Jack**

**14) Speaker**

**15) Aspect**

Adjust aspect ratio in the order of 4:3, 16:9, Fill, Native.

**16) Knob for Adjustment or Enter**

Knob used to adjust Brightness / Contrast / Chroma / Phase or Enter button.

# Rear

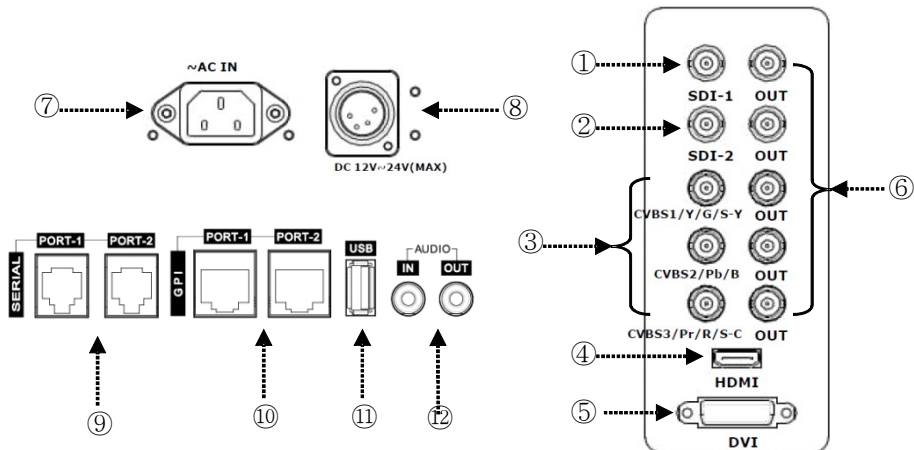
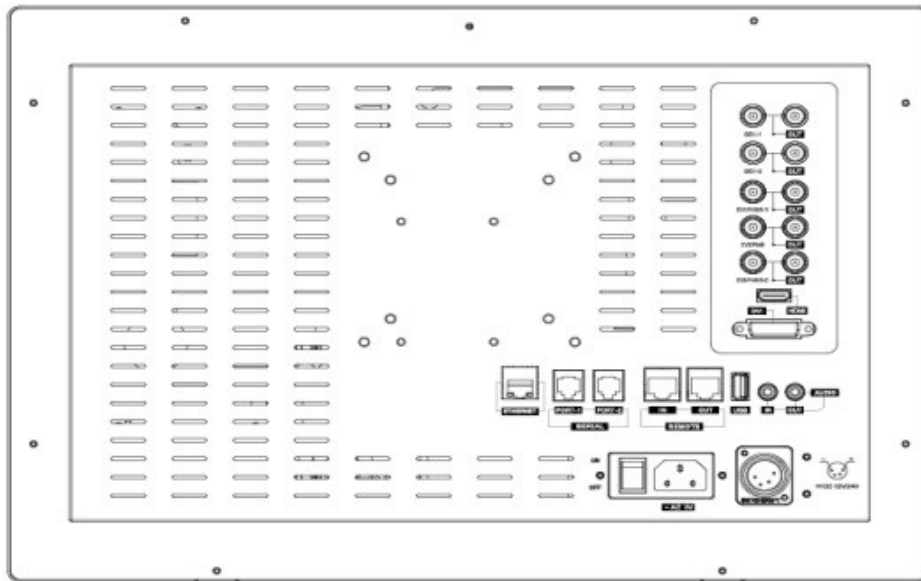

## 1,2) SDI Port

## 3) Component YPbPr/RGB or CVBS 1,2,3 Port

## 4) HDMI Port

## 5) DVI-I Port

## 6) Loop-Through Out for SDI-1/SDI-2 or YPbPr

## 7) AC Input

Please check Power Cord, Power Voltage, Supply power for power input are suitable for the standard before use.

Please do not mix AC power and DC power as it may cause the defects or fire.

### **8) DC Input**

For DC power supply. Check the DC Input voltage. In case of using the Battery power, DC 11 ~ 27V is usable.

### **9) Update Port**

The Serial communication terminal that for changing the operating program(Firmware) of the body or controlling the monitor.

### **10) Remote Ethernet Port**

External control via PC is able with this port by using 'Wall Control Program'. Firmware is also updatable through this port.

### **11) USB Port**

USB Firmware Update Port.

### **12) Power Button**

Power turns off when pressed for one second.

### **13) Tally Lamp**

Tally lamp displays Red, Green, Amber color tally.

### **14) Focus Assist**

Displays focus area when pressed. The focus sensitivity is adjustable on the display menu.

### **15) R/G/B/Gray Only**

Displays Red, Green, Blue or Gray only as the button is pressed.

### **16) Audio Out**

Stereo phone jack for audio output.

### **17) Menu Button**

Menu and Exit button.

### **18) Knobs**

Brightness, Contrast, Chroma, Volume adjustable knobs. The brightness knob is also used as arrow knob to move up and down on the menu, User Zoom, etc.

## **MENU Description**

### **General Cautions for OSD menu or Display**

The menu may not be displayed even when user pressed Menu button if there's No Signal, or in unclear signal status.

The menu selection may be saved for each input signal mode, so sometimes user should do menu selection again.



## VIDEO

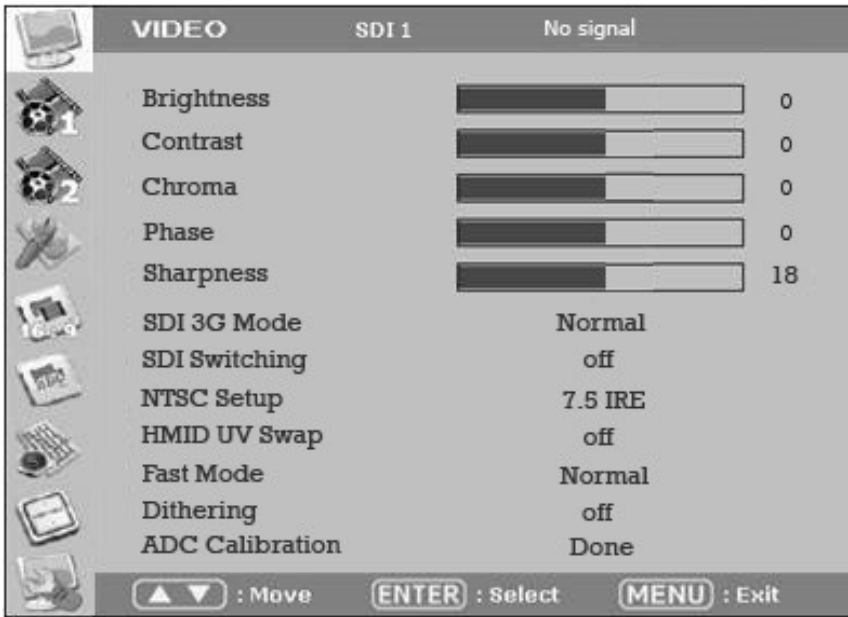

### **Brightness, Contrast, Chroma, Phase, Sharpness**

Adjust color representation values.

### **SDI 3G Mode**

Turns on SDI 3G mode to accept 3G signal.

### **SDI Switching**

Normal : Use Normal in general condition but the screen might be blinking on screen change when you use Matrix or Routing Switcher.

Fast : Use Fast to minimize blinking on screen change.

### **NTSC Setup**

Select IRE among 0 or 7.5 (Default)

### **HDMI UV Swap**

Sometimes color might be swapped on some HDMI input such as PC RGB. Turn this mode on to return to correct color.

### **Fast Mode**

Use this mode to minimize afterimage on very fast video.

### **Dithering**

Turn this mode on to view motion pictures smoothly when the source has low quality.

## DISPLAY 1

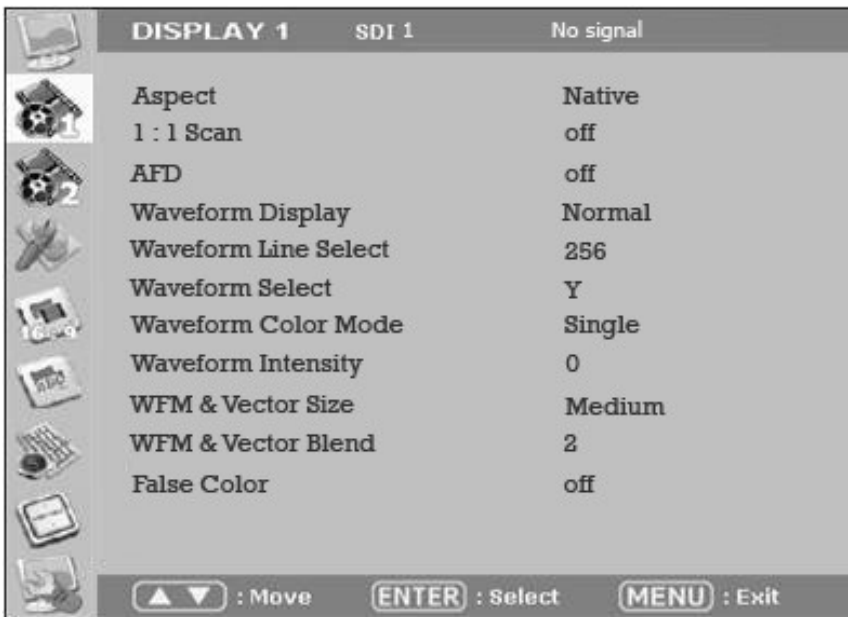

### Aspect

Set the aspect ratio of the screen. 16:9, 4:3, Native(Original) are selectable.

### 1:1 Scan

Set this on to display picture in 1:1 pixel mapping.

### AFD

Set this mode to set aspect ratio.

### Waveform Display

Select waveform display mode. Choose Normal to analyze whole screen, choose Line Select to analyze a specific line of the screen.

### Waveform Line Select

Select the line when you select Line Select mode for Waveform display.

### Waveform Select

Select waveform line to display among Y, Cb, Cr.

### Waveform Color Mode

Select waveform color mode among Single or Mix.

**WFM & VS Position**

Set the position of Waveform/Vector Scope on screen.

**False Color**

Turn False Color mode on to check exposure levels of the picture.

## DISPLAY 2

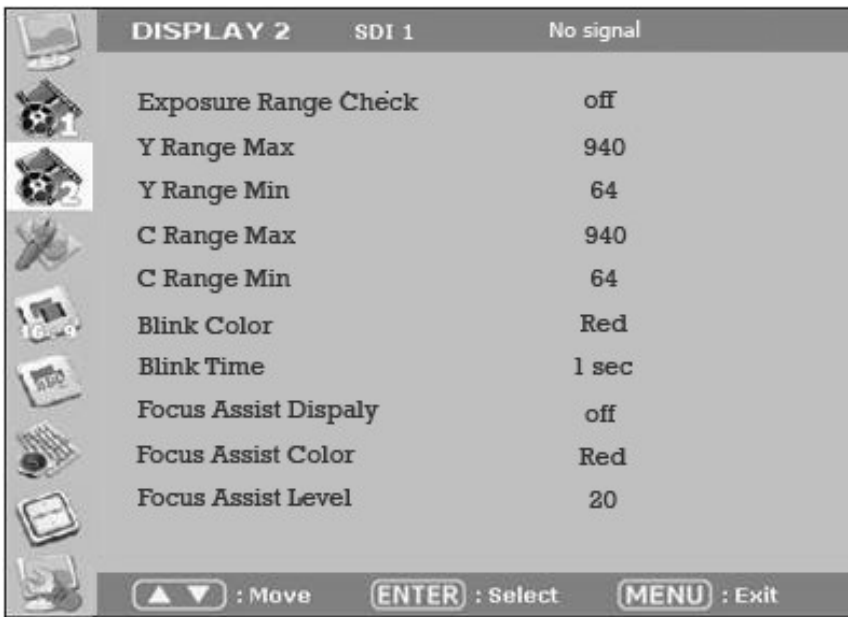

| DISPLAY 2            | SDI 1 | No signal |
|----------------------|-------|-----------|
| Exposure Range Check |       | off       |
| Y Range Max          |       | 940       |
| Y Range Min          |       | 64        |
| C Range Max          |       | 940       |
| C Range Min          |       | 64        |
| Blink Color          |       | Red       |
| Blink Time           |       | 1 sec     |
| Focus Assist Display |       | off       |
| Focus Assist Color   |       | Red       |
| Focus Assist Level   |       | 20        |

▲ ▼ : Move    ENTER : Select    MENU : Exit

### Exposure Range Check (Video Range Check)

Checks Y, C level and displays over-exposed or under-exposed area on screen. The base value can be Y, Cb, or Cr.

### Y Range Max / Min

Set Y range value for range check.

### C Range Max / Min

Set C range value for range check.

### Blink Color

The filled area color by range check can be either Black, Blue, Green or Red.

### Blink Time

Set blinking time of the area between 1 to 5 seconds.

### Focus Assist Display

Turns on Focus Assist mode. This mode can be set also by pressing Focus Assist button in front.

### Focus Assist Level

The sensitivity of the focus assist function can be set between 0 to 48.

**Focus Assist Color**

Set brush color of focus assist mode among Blue, Green, and Red.

# COLOR

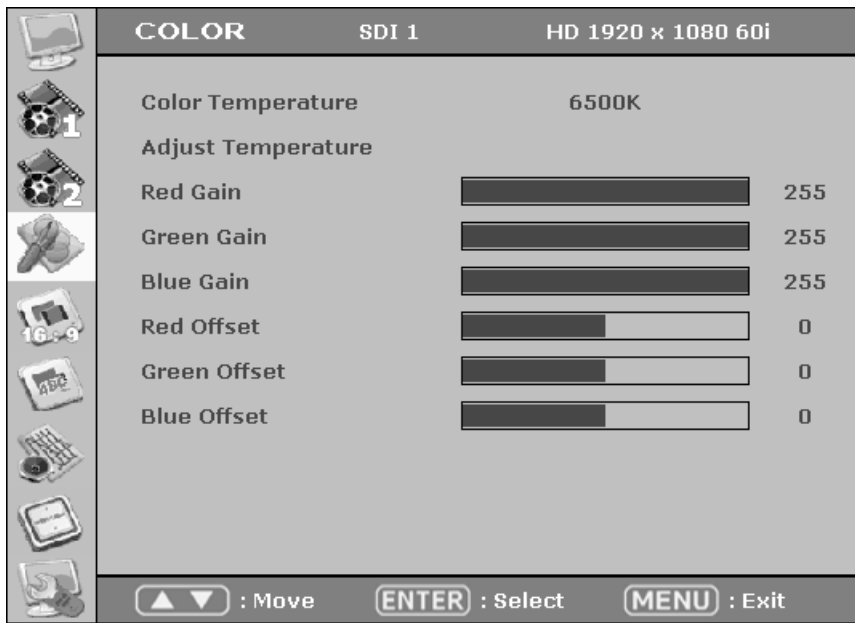

## Color Temperature

Select color temperature among 3200K, 5400K, 6500K, 9300K or USER. (Gain and Offset menu are displayed on USER temperature only)

## Red/Green/Blue Gain (USER mode only)

R,G,B gains are adjustable on User mode.

## Red/Green/Blue Offset (USER mode only)

R,G,B offsets are adjustable on User mode.

## MARKER

|   | MARKER             | SDI 1 | No signal |
|---|--------------------|-------|-----------|
| 1 | Marker Ratio       |       | 4 : 3     |
|   | Center Marker      |       | on        |
| 2 | Safety Area 16 : 9 |       | 88%       |
|   | Safety Area 4 : 3  |       | 88%       |
|   | Marker Color       |       | White     |
|   | Marker Mat         |       | Normal    |
|   | Marker Thickness   |       | 4         |
|   | User Marker H1     |       | 0         |
|   | User Marker H2     |       | 1366      |
|   | User Marker V1     |       | 0         |
|   | User Marker V2     |       | 768       |

▲ ▼ : Move    ENTER : Select    MENU : Exit

### Marker Ratio

Select one of preset markers or user marker. To display marker, press Marker button in front of the monitor.

### Center Marker

Set preference to display center marker or not.

### Safety Area 16:9

Adjust size of the safety area when marker displayed on 16:9 screen.

### Safety Area 4:3

Adjust size of the safety area when marker displayed on 4:3 screen.

### Marker Color

Select marker's color among White, Red, Green, Blue, Gray and Black.

### Marker Mat

Set how to display outside of the safety area. Normal, Half(Gray), Black are selectable.

### Marker Thickness

Set marker thickness between 1 to 10.

### **User Marker H1 / User Marker H2 / User Marker V1 / User Marker V2**

Set user marker's position. H1 for left, H2 for right, V1 for top, V2 for bottom. The positions are saved as the selected marker name such as USER1.



## OSD

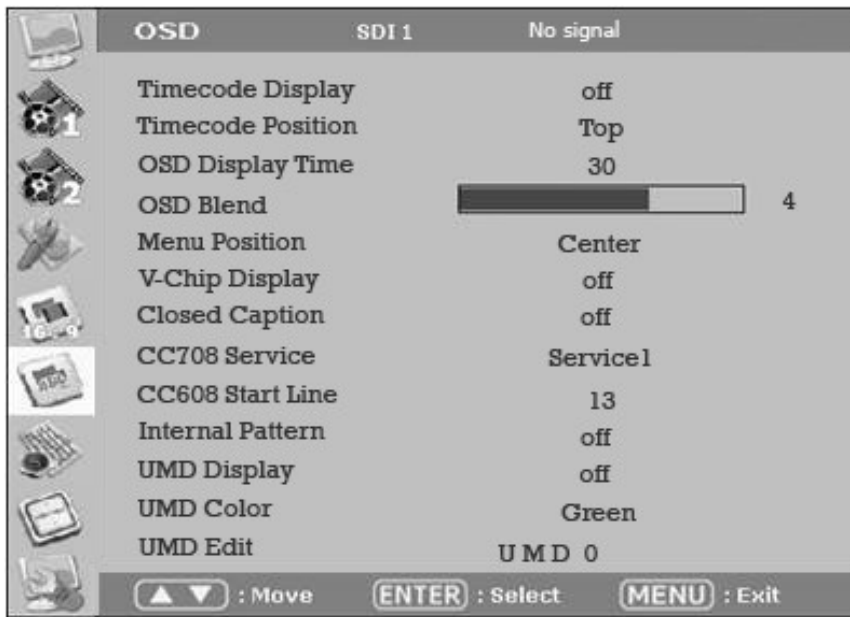

### Timecode Display On/Off

### Timecode Position

Set the position of timecode.

### OSD Display Time

Set menu display time (seconds)

### MENU Position

Set menu position among Left Top, Right Top, Left Bottom, Right Bottom and Center.

### V-Chip

SD-SDI, Composite signal might contain V-Chip data. Turn this mode on to display V-Chip information on screen.

### Closed Caption

Select one of 608 Line 21, 608 VANC, 608 Transcoded, 708 to display Closed Captions. In special condition such as menu display status, captions are not displayed.

### CC708 Service

Select one of CC service as your preference.

Service 1: general captions.

Service 2: translated captions.

Service 3,4: not assigned.

### **CC608 StartLine**

Display line of captions are selectable by user. (e.g. 13)

### **Internal Pattern**

Show internal test pattern such as color bars. Turn this mode off to display general pictures from input port.

### **UMD Display**

Display UMD status. The screen aspect ratio will turn to 16:9 on this mode.

### **UMD Color**

Set UMD color.

### **UMD Edit**

Edit UMD text.

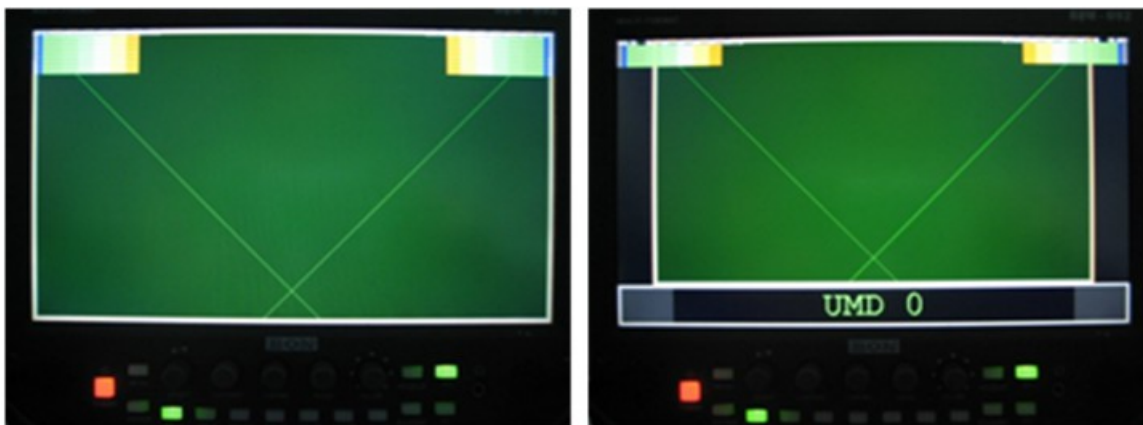

UMD Off

UMD On

## OSD 2

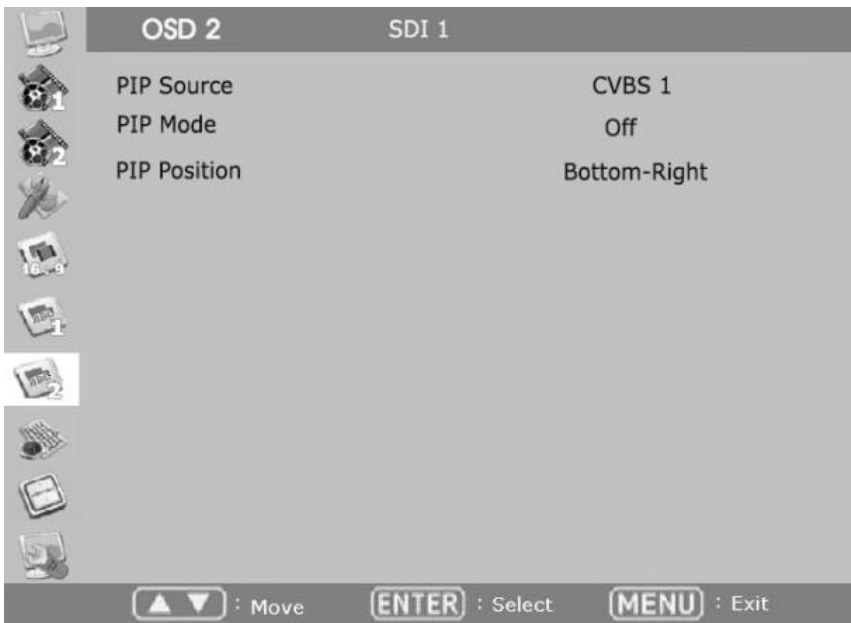

### **PIP Source**

Select Picture-in-Picture source.

### **PIP Mode**

Large PIP, Small PIP, Side by Side can be selected.

### **PIP Position**

Sets sub-picture position.

## AUDIO

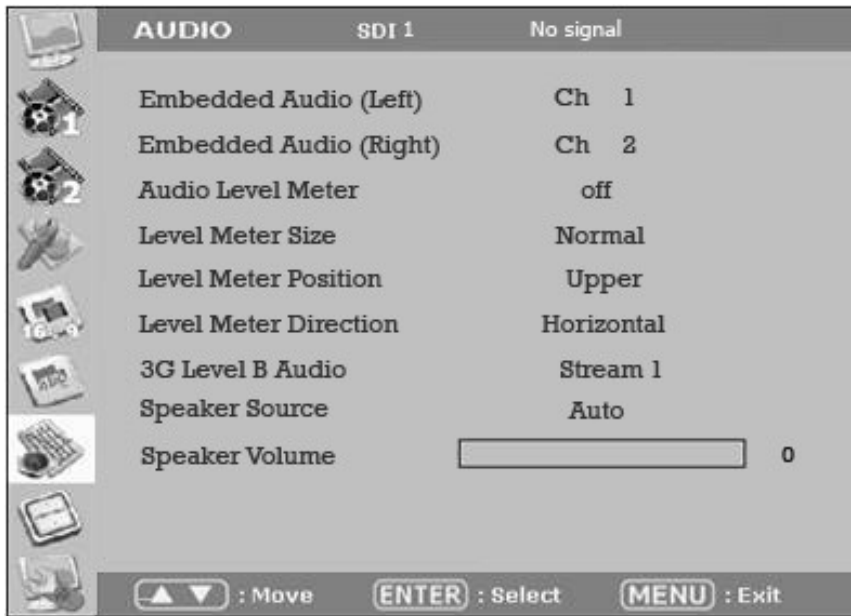

### Embedded Audio Left

Select audio channel for left (Ch 1 ~ 15)

### Embedded Audio Right

Select audio channel for right (Ch 2 ~ 16)

### Audio Level Meter

Turns on/off audio level meters.

### Level Meter Size

Select the size of the meters : Small or Large.

### Level Meter Position

Select the position of the meters : Upper or Lower.

### Level Meter Direction

Select Level Meter orientation among Horizontal or Vertical.

### 3G Level B Audio

Select one Audio source if 3G SDI is used, which has two audio sources.

### Speaker Source

Select the speaker output among Auto / SDI / Line In. For HDMI, use Auto mode.

## **Speaker Volume**

Set volume of speaker.

## GPI

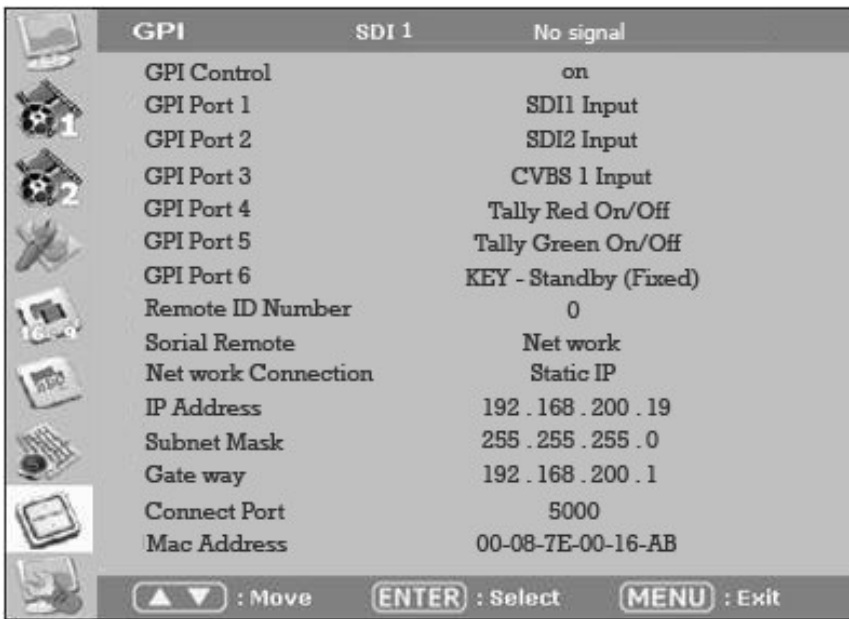

|   | GPI                 | SDI 1 | No signal             |
|---|---------------------|-------|-----------------------|
|   | GPI Control         |       | on                    |
| 1 | GPI Port 1          |       | SDI1 Input            |
|   | GPI Port 2          |       | SDI2 Input            |
| 2 | GPI Port 3          |       | CVBS 1 Input          |
|   | GPI Port 4          |       | Tally Red On/Off      |
|   | GPI Port 5          |       | Tally Green On/Off    |
|   | GPI Port 6          |       | KEY - Standby (Fixed) |
|   | Remote ID Number    |       | 0                     |
|   | Serial Remote       |       | Net work              |
|   | Net work Connection |       | Static IP             |
|   | IP Address          |       | 192 . 168 . 200 . 19  |
|   | Subnet Mask         |       | 255 . 255 . 255 . 0   |
|   | Gate way            |       | 192 . 168 . 200 . 1   |
|   | Connect Port        |       | 5000                  |
|   | Mac Address         |       | 00-08-7E-00-16-AB     |

▲ ▼ : Move    ENTER : Select    MENU : Exit

### GPI Control

Turns on/off external monitor control function.

### GPI Port 1,2,3,4,5,6

Assigns each GPI port's function. (e.g. SDI 1 input, HDMI input, Tally Red) See **EXTERNAL REMOTE CONTROLLING** section for details.

### Remote ID Number

Assigns the ID for the monitor to control through serial port. 0 to 99 can be assigned.

### Serial Remote

Turns serial remote function on. All front buttons are locked on this mode. To exit from this mode, press and hold Menu button for 3 seconds.

### Network Connection

To connect to a network, user should set 'Serial Remote' to Network and use this menu. Choose DHCP (Auto IP) or Static IP here.

To use Static IP, type all the information including IP Address, Subnet Mask and Gateway. Otherwise to use DHCP, connect network cable to a proper Router that can handle all the connection automatically.

**Connection Port**

This port should be assigned to each monitor device differently to distinguish each one. If you use a single monitor to control, you can leave it unchanged.

**MAC Address**

This address is unique address for each network device. User does not need to change it.

## SYSTEM

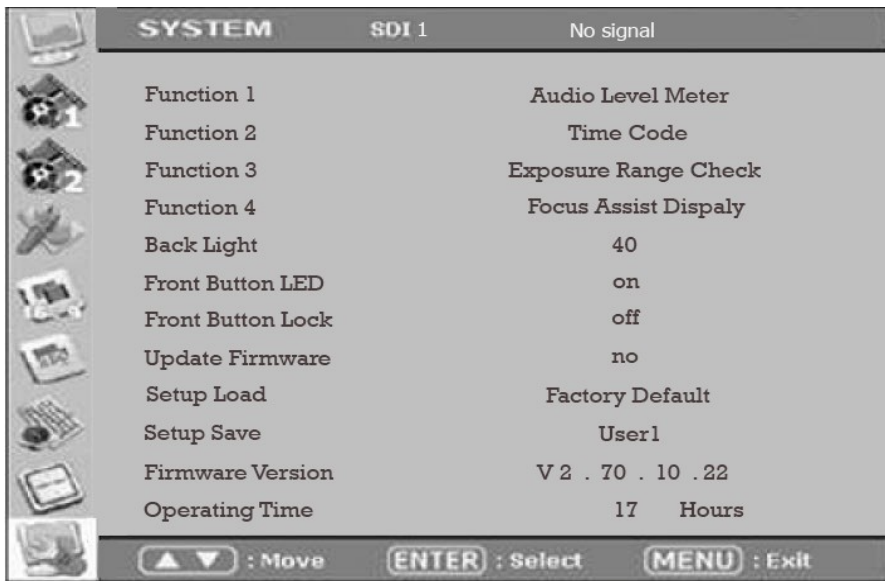

### Function 1,2,3,4

Assigns a function to each function button. See **FRONT** section for detail.

### Backlight

Set the backlight intensity from 0 to 40. An LCD panel requires more than 30 minutes to be settled to a new backlight value.

### Front Button LED

Set front LEDs on/off status.

### Font Button Lock

Locks front buttons not to work. Press and hold Menu button for 3 seconds to exit from this mode.

### Update Firmware

Turns update mode on. Select Serial or USB port for update. After firmware update, the monitor should be turned off/turned on, and Factory Default should be loaded before use.

### Setup Load

Load monitor settings from Factory Default, User 1/2/3/4.

### Setup Save

Save current monitor setting to use later. 4 settings can be saved.



**Firmware Version**

This version number is required when you request for service.

**Operating Time**

This indicates total hours that the monitor operated.

## USB Firmware Update

To update your monitor's firmware, request for a new firmware file to your local reseller or to BON Electronics.

Move the file on a USB flash memory, insert it to your monitor. Please beware the file should be located in the root(top folder level), not in any folder.

Also, the USB flash memory **should have** FAT32 or FAT file system. (General USB memory has FAT32 file system, usually)

Set Update Firmware item as USB from SYSTEM menu.

**Some part of firmware cannot be updated by USB updating procedure, so please get help from your local dealer or expert before you update firmware with USB memory.**

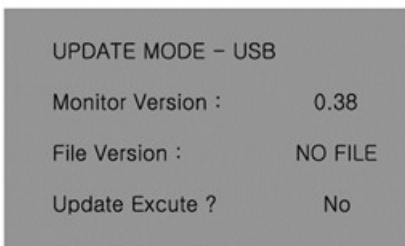

*Error Message when USB access  
or file not exist*



*Message when file on USB  
detected*

You can also use Serial Port and your PC to update the firmware. Please request for help to your local dealer or directly to BON Electronics.

## External Remote Control

### Connecting GPI Port(RJ-45)

#### Update Port (RJ-11)

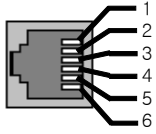

Update (RJ-11)

| Update Terminal Assignment |     |       |     |
|----------------------------|-----|-------|-----|
| 1 PIN                      | NC  | 4 PIN | GND |
| 2 PIN                      | RX+ | 5 PIN | TX+ |
| 3 PIN                      | RX- | 6 PIN | TX- |

\* Turn power off first and connect update cable when you update monitor firmware.

#### Remote Control / GPI Port Pin Assignments

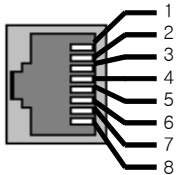

Remote (RJ-45)

| Remote PIN Assignment |            |       |                                  |
|-----------------------|------------|-------|----------------------------------|
| 1 PIN                 | GPI Port 1 | 5 PIN | GPI Port 5                       |
| 2 PIN                 | GPI Port 2 | 6 PIN | GPI Port 6                       |
| 3 PIN                 | GPI Port 3 | 7 PIN | GPI Port 7(FIXED)<br>(TALLY OUT) |
| 4 PIN                 | GPI Port 4 | 8 PIN | COMMON(GND)                      |

Each pin's functionality can be assigned on OSD System Menu, GPI Control section.

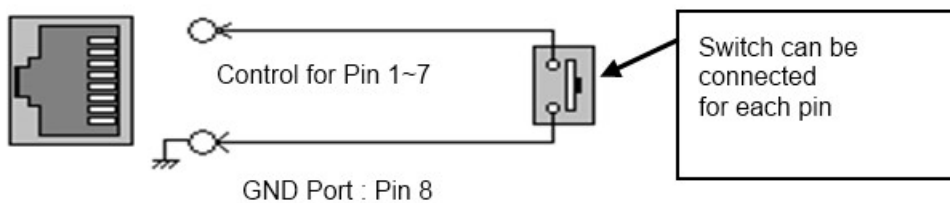

Assignable functions are listed below.

| Function Name           | Description                       |
|-------------------------|-----------------------------------|
| SDI-1 Input             | Switches the input to SDI-1       |
| SDI-2 Input             | Switches the input to SDI-2       |
| HDMI Input              | Switches the input to HDMI        |
| YPbPr Input             | Switches the input to YPbPr       |
| CVBS-1 Input            | Switches the input to CVBS-1      |
| CVBS-2 Input            | Switches the input to CVBS-2      |
| CVBS-3 Input            | Switches the input to CVBS-3      |
| KEY-UP ▲                | CURSOR UP on Menu Control.        |
| KEY-DOWN ▼              | CURSOR DOWN on Menu Control.      |
| KEY- MENU               | Menu On/Off                       |
| KEY-ENTER               | Enter Button                      |
| Aspect                  | Aspect On/Off                     |
| 1:1 Scan On/Off         | 1:1 SCAN Function On/Off          |
| H/V Delay On/Off        | H/V Delay Function On/Off         |
| TC Display On/Off       | TC Display On/Off                 |
| ALM Display On/Off      | Audio Level Meters Display On/Off |
| Freeze On/Off           | Freeze Frame On/Off               |
| Front Button LED On/Off | Front Button LED On/Off.          |
| Tally Red On/Off        | Tally Red LED On/Off              |
| Tally Green On/Off      | Tally Green LED On/Off            |

## List of Compatible Video Formats (HDMI/Composite)

| NO | Signal Input Formats | INPUT            |               |
|----|----------------------|------------------|---------------|
|    |                      | Composite SD-RGB | HD-YPbPr HDMI |
| 1  | NTSC                 | O                | O             |
| 2  | PAL                  | O                | O             |
| 3  | 720*576/50i          | X                | O             |
| 4  | 720*480/59.94i       | X                | O             |
| 5  | 720*480/60i          | X                | O             |
| 6  | 720*576/50p          | X                | O             |
| 7  | 720*480/59.94p       | X                | O             |
| 6  | 720*480/60p          | X                | O             |
| 8  | 1280*720/23.98p      | X                | O             |
| 9  | 1280*720/24p         | X                | O             |
| 10 | 1280*720/25p         | X                | O             |
| 11 | 1280*720/29.97p      | X                | O             |
| 12 | 1280*720/30p         | X                | O             |
| 13 | 1280*720/50p         | X                | O             |
| 14 | 1280*720/59.94p      | X                | O             |
| 15 | 1280*720/60p         | X                | O             |
| 16 | 1920*1080/50i        | X                | O             |
| 17 | 1920*1080/59.94i     | X                | O             |
| 18 | 1920*1080/60i        | X                | O             |
| 19 | 1920*1080/23.98p     | X                | O             |
| 20 | 1920*1080/24p        | X                | O             |
| 21 | 1920*1080/25p        | X                | O             |
| 22 | 1920*1080/29.97p     | X                | O             |
| 23 | 1920*1080/30p        | X                | O             |
| 24 | 1920*1080/50p        | X                | O             |
| 25 | 1920*1080/59.94p     | X                | O             |
| 26 | 1920*1080/60p        | X                | O             |

## List of Compatible Video Formats (SDI)

| NO | Input Signal Formats | HD/SD-SDI |             |             |           |
|----|----------------------|-----------|-------------|-------------|-----------|
|    |                      | Single    | 3G YUV4:2:2 | 3G YUV4:4:4 | 3G RGB444 |
| 1  | NTSC                 | Y         | -           | -           | -         |
| 2  | PAL                  | Y         | -           | -           | -         |
| 3  | 525/60i (SD)         | Y         | -           | -           | -         |
| 4  | 625/50i (SD)         | Y         | -           | -           | -         |
| 5  | 720*480/59.94p       | -         | -           | -           | -         |
| 6  | 720*576/50p          | -         | -           | -           | -         |
| 7  | 1280*720/23.98p      | -         | -           | -           | -         |
| 9  | 1280*720/24p         | -         | -           | -           | -         |
| 9  | 1280*720/50p         | Y         | -           | Y           | Y         |
| 10 | 1280*720/59.94p      | Y         | -           | Y           | Y         |
| 11 | 1280*720/60p         | Y         | -           | Y           | Y         |
| 12 | 1920*1035/59.94i     | Y         | -           | Y           | Y         |
| 13 | 1920*1035/60i        | Y         | -           | Y           | Y         |
| 14 | 1920*1080/50i        | Y         | -           | Y           | Y         |
| 15 | 1920*1080/59.94i     | Y         | -           | Y           | Y         |
| 16 | 1920*1080/60i        | Y         | -           | Y           | Y         |
| 17 | 1920*1080/23.98p     | Y         | -           | Y           | Y         |
| 18 | 1920*1080/23.98psf   | Y         | -           | Y           | Y         |
| 19 | 1920*1080/24p        | Y         | -           | Y           | Y         |
| 20 | 1920*1080/24psf      | Y         | -           | Y           | Y         |
| 21 | 1920*1080/25p        | Y         | -           | Y           | Y         |
| 22 | 1920*1080/25psf      | Y         | -           | Y           | Y         |
| 23 | 1920*1080/29.97p     | Y         | -           | Y           | Y         |
| 24 | 1920*1080/29.97psf   | Y         | -           | Y           | Y         |
| 25 | 1920*1080/30p        | Y         | -           | Y           | Y         |
| 26 | 1920*1080/30psf      | Y         | -           | Y           | Y         |
| 27 | 1920*1080/50p        | -         | Y           | -           | -         |
| 28 | 1920*1080/59.94p     | -         | Y           | -           | -         |
| 29 | 1920*1080/60p        | -         | Y           | -           | -         |
| 30 | 2048*1080/23.98p     | Y         | -           | -           | Y         |
| 31 | 2048*1080/23.98      | Y         | -           | -           | Y         |

|    |                      |   |   |   |   |
|----|----------------------|---|---|---|---|
|    | psf                  |   |   |   |   |
| 32 | 2048*1080/24p        | Y | - | - | Y |
| 33 | 2048*1080/24psf      | Y | - | - | Y |
| 34 | 2048*1080/25p        | - | - | - | Y |
| 35 | 2048*1080/25psf      | - | - | - | Y |
| 36 | 2048*1080/29.97<br>p | - | - | - | Y |
| 37 | 2048*1080/30p        | - | - | - | Y |

## Specifications

|                                |   | BSM-093N3G   | BSM-183N3G                                       | BSM-212N3G   | BSM-242N3G            |
|--------------------------------|---|--|--|--|-----------------------|
| Input                          | 2 x HD/SD-SDI   | 3G/ HD/SD-SDI, 2.97G/1.485G/270M                   |  |  |                       |
|                                | 3 x Analog  | Analog(YPbPr/CVBS/S-Video/RGB)                     |  |  |                       |
|                                | 1 x HDMI  | HDMI (with HDCP v.1.1), 19pin Female               |  |  |                       |
|                                | 1 x DVI   | DVI-I, 24pin, Female                               |  |  |                       |
|                                | 1 x VGA   | DVI-I to VGA Jack (with gender)                    |  |  |                       |
| Output                         | 2 x BNC   | SDI-1/2 Active Loop Output                         |  |  |                       |
|                                | 3 x BNC   | Analog(YPbPr/RGB/CVBS1/CVBS2/CVBS3/S-Video)        |  |  |                       |
| I/O Port                       | 2 x GPIO  | GPI-7 Port, RJ-45P Jack                            |  |  |                       |
|                                | 2 x Serial  | RS-422, RJ-11P Jack                                |  |  |                       |
|                                | 1 x USB   | for firmware update                                |  |  |                       |
| LAN Port                       | 1 x Ethernet  | Wall System Control Or Firmware Update             |  |  |                       |
| LCD                            | Size  | 9"   | 18.5"  | 21.5"  | 24"                   |
|                                | Resolution  | 960 * 540  | 1366 * 768                                       | 1920 * 1080  | 1920 * 1200           |
|                                | Pixel Pitch   | 0.207mm  | 0.1 * 0.3 mm                                     | 0.082*0.247 mm                                     | 0.27 * 0.27mm         |
|                                | Color Depth   | 16.7M(8-bit)                                       | 16.7M(6bit+2FR C)                                | 16.7M(6bit+A-FRC)                                  | 16.7M(6bit+A-FRC)     |
|                                | Viewing Angle(deg)  | 170(H) 170(V)                                      | 178(H), 178(V)                                   | 178(H), 178(V)                                     | 178(H), 178(V)        |
|                                | Luminance of White  | 400 cd/m <sup>2</sup>                              | 250 cd/m <sup>2</sup>                            | 250 cd/m <sup>2</sup>                              | 350 cd/m <sup>2</sup> |
|                                | Contrast  | 1000 : 1   | 1000 : 1   | 1000 : 1   | 1000 : 1              |
|                                | Back Light  | LED  | LED  | LED  | LED                   |
|                                | Display Area (H X V)  | 198.72 x 111.78 mm                                 | 409.8 X 230.4 mm                                 | 476.06 X267.78 mm                                  | 518.4 X 324.0mm       |
| Power Requirements             | DC 12V/24V, AC(100-230V, 50/60Hz)                                   | DC 12V/24V, AC100-230V                             | DC 12V/24V, AC100-230V                           | DC 12V/24V, AC100-230V                             |                       |
| Screen Type                    | IPS   |  |  |  |                       |
| Response Time                  | 8ms   | 9ms  | 8ms  | 8ms  |                       |
| Power Consumption              | 25W   | 45W  | 55W  | 56W  |                       |
| Operating Temperature          | 0°C ~ 40°C  |  |  |  |                       |
| Operating Humidity             | 20% ~ 80% RH  |  |  |  |                       |
| Dimension(W*H*D) w/o Box&Stand | 223 x 174 x 50.2 mm / 8.7 x 6.8 x 1.9 inches                        | 438.4 x 310.8 x 66.4 mm / 17.2 x 12.2 x 2.6 inches | 505.6 x348.0 x 59.2mm / 19.9 x 13.7 x 2.3 inches | 553.4 x 403.5 x 62.5 mm / 21.7 x 15.8 x 2.4 inches |                       |
| Accessory                      | • AC Power Cord • Manual (CD) • Cleaner                             |  |  |  |                       |
| Option                         | • Rack Mount, Vertical/Wall Mount, Acrylic Protector, Carrying Case |  |  |  |                       |



## BSM-173N3G Specifications

|                      |  |
|----------------------|--|
| LCD                  |  |
| Size                 | 17.3"  |
| Resolution           | 1920 x 1080  |
| Pixel Pitch          | 0.1989*0.1989 mm   |
| Color                | 16.7M(6bit+HiFRC) Colors   |
| Viewing Angle        | 160(H), 140(V)   |
| Luminance of White   | 400 cd/m <sup>2</sup>  |
| Contrast             | 600 ; 1  |
| Back Light           | LED  |
| Display Area (H x V) | 381.888 x 214.812 mm (15.0 x 8.5 inches)                                   |
| Input                |  |
| 2 x BNC              | HD/SD-SDI, 3G/1.485G/270M  |
| 3 x BNC              | Analog(YPbPr/CVBS/S-Video/RGB)   |
| 1 x HDMI             | HDMI (with HDCP v.1.1), 19pin Female                                       |
| 1 x DVI              | DVI-I, 24pin, Female   |
| 1 x VGA              | DVI-I to VGA Jack (with gender)  |
| Output               |  |
| 2 x BNC              | SDI-1/2 Active Loop Output   |
| 3 x BNC              | Analog(YPbPr/CVBS/S-Video/RGB)   |
| Analog Input Level   |  |
| Composite            | 1.0Vp-p(with sync), NTSC/PAL   |
| YC(S-Video)          | Y :1.0Vp-p, C:0.286Vp-p  |
| Component(Y/Pb/Pr)   | Y :1.0Vp-p, Pb :0.7Vp-p, Pr :0.7Vp-p                                       |
| Component (R/G/B)    | G :1.0Vp-p(with Sync), B :0.7Vp-p, R : 0.7Vp-p                             |
| PC-RGB,Sync Level    | R, G, B : 0.7Vp-p, H/V Sync : 4V ± 1Vp-p                                   |
| Input Signal Format  |  |
| SMPTE 425M AB        | 1080p<br>(60/59.94/50/30/29.97/25/24/23.98/30sF/29.97sF/25sF/24sF/23.98sF) |
|                      | Level B MS1, MS2, MS3, MS4   |
| SMPTE 372M           | Dual HD-SDI YCbCr (4:2:2), 1080p   |
|                      | Dual HD-SDI YCbCr/RGB (4:4:4), 1080i, 1080p, 720p                          |
| 2K, SMPTE 428M       | 2048*1080,24p/psf,23.98p/psf   |
| SMPTE 274M/292M      | 1920*1080i (60, 59.94, 50)   |
|                      | 1920*1080p (30, 29.97, 25, 24, 24sF, 23.98, 23.98sF)                       |
| SMPTE 296M           | 1280*720p/60,59.94,50  |
| SMPTE 260M           | 1920*1035i/60,59.94  |

|                       |   |
|-----------------------|---|
| SMPTE 125M/259M       | 720*480i/60,59.94, 720*576i/50  |
| ITU R-BT.656          | 576i(50)  |
| Composite             | 720*480i(NTSC)/576i(PAL)  |
| Component, VGA        | 480i/p ~ 1920 * 1080i/p   |
| DVI Signal            | 480i/p ~ 1920 * 1080i/p   |
| HDMI Digital          | ~ 1920 * 1200i/p(de-embedded Audio 2ch)                                   |
| Audio Input/Output    |   |
| 1 x Phone Jack In     | Line In(Stereo)   |
| 2 x Phone Jack Out    | Line Out(Rear,Stereo), Headphone Out(Front, Stereo)                       |
| 2 x Speaker Out       | 1.5W+1.5W, Stereo   |
| General               |   |
| 1 x Ethernet          | Control/Update, GPI-7 Port, RJ-45P Jack                                   |
| 2 x GPIO              | GPI-7 Port, RJ-45P Jack   |
| 2 x Serial            | RS-422, RJ-11P Jack   |
| 1x USB                | For firmware update   |
| Power Requirements    | DC 12V/24V, AC100-230V(50/60Hz)   |
| Power Consumption     | 39W   |
| Operating Temperature | 0°C ~ 40°C (32°F~104°F)   |
| Operating Humidity    | 20% ~ 80% RH  |
| Weight                | 5 kg (11 lbs)   |
| Accessories           | • Manual(CD) • Cleaner • Power Cable • DVI-to-VGA Gender                  |
| Options               | • Acrylic protector • Sun Hood • Carrying Case • Rack Mount Kit • V-Mount |

## Dimensions

### **BSM-093N3G**

223 x 174 x 50.2 mm  
(8.7 x 6.8 x 1.9 inches)

### **BSM-173N3G**

411 x 299 x 62mm  
(16.1 x 11.7 x 2.4 inches)

### **BSM-183N3G**

438.4 x 310.8 x 66.4mm  
(17.2 x 12.2 x 2.6 inches)

### **BSM-213N3G**

505.6 x 348.0 x 59.2mm  
(19.9 x 13.7 x 2.3 inches)

### **BSM-243N3G**

553.4 x 403.5 x 62.5 mm  
(21.7 x 15.8 x 2.4 inches)

## Troubleshooting

Try these if you have trouble in using the monitor. Call for Service if you can't solve the problem even after you tried these solutions.

| Symptom  | Solution  |
|--|---|
| Power isn't turned on  | Check Connectivity of Power Cable between Outlet and the Monitor.<br>Press and Hold Power button for more than one second.<br>Try with Other Monitor or Electric Device using the same Power Cable.   |
| Screen is Black and All Button Lights are On in startup process  | Reconnect the Power and Restart the Monitor.<br>(Call for Service if the Symptom appeared more than 3 times)  |
| Screen is Black on Startup and there's neither BON Logo nor "No Signal" Display, but Buttons are Working | Reconnect the Power and Restart the Monitor.<br>(Call for Service if the Symptom appeared more than 3 times)  |
| There's a delay in BON Logo Display on Startup   | It is normal and No Reaction Required.  |
| BON Logo appeared on Startup, but No Screen Output when Input Signal Connected                           | Remove Input Cable and Check if "No Signal" appears on Screen.<br><ul style="list-style-type: none"> <li>- restart the Monitor if you can't see "No Signal"</li> <li>- Make Monitor "Factory Default" and Try again and Try again</li> <li>- Check the Cable Connectivity</li> <li>- Try with Different Cable</li> <li>- Check the Input Format and Frequency</li> <li>- Try with Different Input Device. If successful, the Failed Input Device may Generate Non-Standard Signal (Please Inform Us its Model Name).</li> </ul> |
| "No Signal" appears on the Screen  | Check the Input Selection.<br>Make Monitor "Factory Default" and Try again.<br>Try with Different Input Cable.<br>Check the Cable Connection.<br>Check if the Input Format and Frequency is Supported.<br>Try with Different Input Device. If successful, the Failed Input Device may Generate Non-Standard Signal (Please Inform Us its Model Name).   |

|  |   |
|--|---|
| Strange Color on BON Logo on Startup                             | Reconnect the Power and Restart the Monitor.<br>(Call for Service if the Symptom appeared more than 3 times)  |
| the Startup Logo Color was ok but Strange Color on Active Screen | Make Monitor "Factory Default" and Try again.<br>Select Test Pattern(Internal Pattern) in the menu and See if R,G,B Color is Correct.<br>Check the Input Selection.<br>Try with Different Cable.<br>Check if Each Cable is correctly Connected when you use Component as Input. |
| Screen Position Mismatch   | Make Monitor "Factory Default" and Try again.<br>Reconnect the Power and Restart the Monitor.<br>Try with Different Input Device. If successful, the Failed Input Device may Generate Non-Standard Signal (Please Inform Us its Model Name).                                    |
| No Audio Output  | Check if the Volume level is 0.<br>Display the Audio Level Meters and See its output.   |
| Colors look different between different models                   | Give your Monitor 1 hour warmup time.<br>Because Different Panels have different Characteristics, Colors might look Different.  |
| Colors look different between same models                        | Give your Monitor 1 hour warmup time.<br>Same Panels are not exactly same but they have a tolerance range among them by the Panel Manufacturer, so Colors might look Different.<br>* The tolerance range is in Panel Standard Document included in CD                           |

## Warranty Information

### Free Service

If the product needs to be repaired in 12 months from the purchase.

### Exceptions

- damage caused by accident, abuse, misuse, water, flood, fire, or other acts of nature or external causes
- damage caused by service performed by anyone who is not an authorized service provider
- damage to a product that has been modified or altered without the written permission of BON

### Service to be Charged

If the product needs to be repaired after 12 months from the purchase.

## Modification of Product

Dimensions, specifications or design of the product are subject to change without prior notice for product improvement.

## Caution on Menu Operation

OSD Menu might be frozen or broken on very high-quality or complicated pictures input. In that case, turn off the power for 5 seconds and turn it on to make Menu works.

## Caution for Monitor Placement

For long lifetime and proper operation of the monitor, all surface of the monitor should not be blocked by any material for ventilation.

## Caution for Usage

This monitor designed to be used for broadcasting purpose. Using it as PC monitor is not recommended.



**BON ELECTRONICS**

**Corporate Headquarters**

Tresebelle-Sky 2F, 1479 Gayang-2, Gangseo-gu, Seoul, South Korea

**Research / Service Center**

Vision Tower 7F, 1481 Gayang-2, Gangseo-gu, Seoul, South Korea

**Telephone**

+ 82 2 2659 0333

**FAX**

+ 82 2 2659 8133

**Web**

<http://www.bon.co.kr>

**Email**

[salesbon@bon.co.kr](mailto:salesbon@bon.co.kr)